



Data Sheet

RISH Ducer TV-808

Isolating amplifier unipolar/bipolar



Measure



Control



Record



Analyze

Application

The purpose of the isolating amplifier **RISHD** inc. TV 808 (Fig.1) is to electrically insulate input and output signals, respectively to amplify and / or change the signal level or type (current or voltage) of the input signals.

The amplifier fulfils all the important requirements and regulations concerning electromagnetic compatibility EMC and safety (IEC 1010 resp. EN 61 010). It was developed and is manufactured and tested in strict accordance with the quality assurance standard ISO 9001.

The device have one/two channels and provides one/two independent isolating amplifiers in an extremely small space. The user has a wide choice of input and output ranges and can set the desired one with the aid of soldered jumpers (coarse adjustment) and potentiometers (fine adjustment).

A version with one input and two outputs is available that enables two electrically insulated outputs to be obtained from a single input signal.

- 252 standard input and output combinations selected by soldered jumpers
- User - specific input and /or output ranges
- Isolating amplifier with one input one or two electrically insulated outputs.
- Power supply 24... 60 VDC / AC or 85... 230 VDC / AC
- Electric Isolation between input, output and power supply, prevents falsified measurement due to spurious potentials.
- Flexibility provided by more than 250 different input and output combinations selected by simply positioning soldered jumpers, helps in reduced stocking.
- Processes unipolar / bipolar and live zero signals provision for raising burden and signal conversion Green LED signals indicates device in operating condition.
- High Electrical Insulation between input and output - 2.3 kV, and power supply versus all other circuits - 3.7 kV
- Provision for either snapping the isolating amplifier onto top - hat rails or securing it with screw to a wall or panel.

Technical Data

Measuring inputs \rightarrow

DC current Standard ranges

0 ... 0.1 mA	0.2 ... 1 mA	- 0.1 ... + 0.1 mA
0 ... 0.2 mA	1 ... 5 mA	- 0.2 ... + 0.2 mA
0 ... 0.5 mA	2 ... 10 mA	- 0.5 ... + 0.5 mA
0 ... 1 mA	4 ... 20 mA	- 1 ... + 1 mA
0 ... 2 mA		- 2 ... + 2 mA
0 ... 5 mA		- 5 ... + 5 mA
0 ... 10 mA		-10 ... +10 mA
0 ... 20 mA		-20 ... + 20 mA

Limit values

0 ... 0.1 to 0 ... 40 mA
 also live - zero,
 start value > 0 to \leq 50 % final value
 or span 0.1 to 40 mA
 between -40 and 40 mA
 also bipolar asymmetrical
 $R_i = 15 \Omega$

DC voltage

Standard ranges

0 ... 0.06 V	0.2 ... 1 V	- 0.1 ... + 0.1 V
0 ... 0.1 V	1 ... 5 V	- 0.2 ... + 0.2 V
0 ... 0.2 V	2 ... 10 V	- 0.5 ... + 0.5 V
0 ... 0.5 V	4 ... 20 V	- 1 ... + 1 V
0 ... 1 V		- 2 ... + 2 V
0 ... 2 V		- 5 ... + 5 V
0 ... 5 V		-10 ... +10 V
0 ... 10 V		-20 ... +20 V
0 ... 20 V		
0 ... 40 V		

Limit values

0 ... 0.06 to 0 ... 40
 also live - zero,
 start value > 0 to \leq 50 % final value
 or span 0.06 to 40 V
 between -40 and 40 V
 also bipolar asymmetrical
 $R_i = 100 \text{ k}\Omega$

Non-Standard input ranges

0...1000V DC input signal

Overload

DC current continuously 2 - fold
 DC voltage continuously 2 - fold

Measuring outputs \rightarrow

DC currents

Standard ranges
 0 ... 20 mA, 4 ... 20 mA, \pm 20 mA
Limit values
 0... 1 to 0 ... 20 mA
 0.2 ... 1 to 4 ... 20 mA
 -1 ... 0 ... + 1 to -20 ... 0 ... + 20 mA

Burden voltage

12 V

External resistance

$$R_{\text{ext max.}} [\text{k}\Omega] \leq \frac{12 \text{ V}}{I_{\text{AN}} [\text{mA}]}$$

I_{AN} = Output circuit full - scale value

DC voltage

Standard ranges
 0 ... 10 V, 2 ... 10 V, \pm 10 V
 Limit values
 0 ... 1 to 0 ... 10 V
 0.2 ... 1 to 2 ... 10 V
 -1 ... 0 ... + 1 to -10 ... 0 ... + 10V

Burden

$$R_{\text{ext min.}} [\text{k}\Omega] \geq \frac{U_{\text{AN}} [\text{V}]}{5 \text{ mA}}$$

U_{AN} = Output circuit full - scale value

Current limiter at $R_{\text{ext max.}}$

Approx. 1.1 x I_{AN} for current output

Voltage limiter at $R_{\text{ext}} = \infty$

Approx. 13 V

Residual ripple in output current

< 0.5% p.p.

Response time

< 50 ms

Accuracy data (acc. to DIN/IEC 770)

Basic accuracy
 Limit error \pm 0.2 %
 Including linearity and reproducibility errors

Reference conditions

Ambient temperature	23 °C ± 2 K
Power supply	24 V DC ± 10% & 230 V AC ± 10%
Output burden	Current : 0.5 · R _{ext} max. Voltage : 2 · R _{ext} min.

Influencing factors

Temperature	< ± 0.1% per 10 K
Burden influence	< ± 0.1% for current output < ± 0.2% for voltage output if R _{ext} < 2 · R _{ext} min.

¹For power supplies >125 V, the auxiliary circuit should include an external fuse with a rating ≤ 20 ADC.

Longtime drift	< ± 0.3% / 12 months
Switch-on drift	< ± 0.2%
Common and transverse mode influence	< ± 0.2%
Output + or – connected to ground	< ± 0.2%

Power supply H

AC/DC power pack (DC and 45...400 Hz)

Table 3: Nominal voltages and tolerances

Nominal voltage U _N	Tolerance
24 ... 60 V DC / AC	DC – 15 ... + 33% AC ± 15%
85 ... 230 V ¹ DC / AC	

Power input ≤ 1.6 W resp. ≤ 3.4 VA

Environmental conditions

Climatic rating	Climate class 3Z acc. to VDI/VDE 3540
Commissioning temperature	–10 to + 55 °C
Operating temperature	– 25 to + 55 °C
Storage temperature	– 40 to + 70 °C
Annual mean relative humidity	≤ 75%

Standard

Electromagnetic compatibility	The standards DIN EN 50 081 - 2 & DIN EN 50 082 - 2 are observed
Protection (acc. to IEC 529 resp. EN 60 529)	Housing IP 40 Terminals IP 20
Electrical standards	Acc. to IEC 1010 resp. En61010
Operating voltages	< 300 V between all insulated circuits
Contamination level	2
Overvoltage category acc. to IEC 664	III for power supply II for measuring input and measuring output
Double insulation	– Power supply versus all other circuits – Measuring input versus measuring output
Test voltage	Power supply versus : – all 3.7 kV, 50 Hz, 1 min Measuring input Versus : – measuring output 2.3 kV, 50Hz, 1 min. Measuring input 1 Versus : – measuring input 2 2.3 kV, 50 Hz, 1 min. Measuring input 1 Versus : – measuring output 2 2.3 kV, 50 Hz, 1 min.

Regulations

Electromagnetic compatibility	The standards DIN EN 50 081-2 & DIN EN 50 082-2 are observed
Protection (acc. to IEC 529 resp. EN 60 529)	Housing IP 40 Terminals IP20 Acc. to IEC 1010 resp. En61010 < 300 V between all insulated circuits
Electrical standards	
Operating voltages	
Contamination level	2

Installation Data

Housing	Housing S 17 See section "Dimensional drawings" for dimensions
Material of housing	Lexan 940 (polycarbonate) flammability class V-0 acc. to UL 94, self-extinguishing, non-dripping, free of halogen
Mounting	For snapping onto top - hat rail (35 x 15 mm or 35 x 7.5mm) acc. to EN 50 022 OR Directly onto a wall or panel using the pull -out screw hole brackets
Position of use	Any
Terminals	DIN / VDE 0609 Screw terminals with wire guards, for light PVC wiring and max. 2 x 0.75mm ² or 1 x 2.5 mm ² Screw M2.5 torque is 0.4 N-m
Permissible vibrations	2 g acc. to EN 60 068-2-6
Shock	3 x 50 g 3 shocks each in 6 directions acc. to EN 60 068 - 2 - 27
Weight	Approx. 0.2 kg
Electrical insulation	All circuit (measuring inputs/ measuring outputs / power supply) are electrically insulated

Configuration

1. Standard input ranges

Soldered jumpers are provided for the coarse setting of the input ranges and the fine adjustment is accomplished using the potentiometers "Zero" and "Span".

100 must be added to the designations of the soldered jumpers in the table for channel 1 and 200 for channel 2.

(Example : Input range for input 1 and input 2 = 0 ... 20 mA
Jumpers 1, 5, 6 and 11 must be inserted for this range.

- The corresponding jumpers for channels 1 are B 101, B 105, B 106 and B 111.
- The corresponding jumpers for channels 2 are B 201, B 205, B 206 and B 211).

Current [mA]	Soldered jumpers			Voltage [V]	Soldered jumpers		
	Channel 1	Channel 2	Channel 3		Channel 1	Channel 2	Channel 3
0 ... 0.1	1, 3	7, 10, 11		0 ... 0.06		6, 9, 10, 11	
0 ... 0.2	1, 3	8, 11		0 ... 0.1		7, 8, 10, 11	
0 ... 0.5	1, 4	9, 10, 11		0 ... 0.2		6, 8, 9, 11	
0 ... 1	1, 4	7, 10, 11		0 ... 0.5		6, 7, 8, 9, 10	
0 ... 2	1, 4	8, 11		0 ... 1	2	6, 7, 8, 10, 11	
0 ... 5	1, 5	6, 7, 8, 10, 11		0 ... 2	2	7, 8, 9, 11	
0 ... 10	1, 5	10, 11		0 ... 5	2	8, 10	
0 ... 20	1, 5	6, 11		0 ... 10	1	10, 11	
				0 ... 20	1	6, 11	
				0 ... 40	1	8	
0.2 ... 1	1, 4	8, 10, 11	12, 15	0.2 ... 1	2	9, 10, 11	12, 15
1 ... 5	1, 4	6, 9	12, 15	1 ... 5	2	6, 8, 9, 10	12, 15
2 ... 10	1, 5	6, 7, 10, 11	12, 15	2 ... 10	1	6, 7, 10, 11	12, 15
4 ... 20	1, 5	6, 7, 8, 11	12, 15	4 ... 20	1	6, 7, 8, 11	12, 15
– 0.1 ... 0 ... + 0.1	1, 3	8, 11	13, 14, 16	– 0.1 ... 0 ... + 0.1		6, 8, 9, 11	13, 14, 16
– 0.2 ... 0 ... + 0.2	1, 3	7, 9	13, 14, 16	– 0.2 ... 0 ... + 0.2		6, 7, 9, 10	13, 14, 16
– 0.5 ... 0 ... + 0.5	1, 4	7, 10, 11	13, 14, 16	– 0.5 ... 0 ... + 0.5	2	7, 8, 10, 11	13, 14, 16
– 1 ... 0 ... + 1	1, 4	8, 11	13, 14, 16	– 1 ... 0 ... + 1	2	7, 8, 9, 11	13, 14, 16
– 2 ... 0 ... + 2	1, 4	6, 9	13, 14, 16	– 2 ... 0 ... + 2	2	6, 8, 9, 10	13, 14, 16
– 5 ... 0 ... + 5	1, 5	10, 11	13, 14, 16	– 5 ... 0 ... + 5	1	10, 11	13, 14, 16
–10 ... 0 ... +10	1, 5	6, 11	13, 14, 16	–10 ... 0 ... +10	1	6, 11	13, 14, 16
–20 ... 0 ... +20	1, 5	6, 7	13, 14, 16	–20 ... 0 ... +20	1	8	13, 14, 16

2. Standard output ranges

Soldered jumpers are provided for the coarse setting of the output ranges and the fine adjustment is accomplished using the potentiometers "Zero" and "Span".

Current mA	Soldered jumpers		Voltage V	Soldered jumpers	
	Channel 1	Channel 2		Channel 1	Channel 2
0 ... 20	B 120	B 220	0 ... 10	B 120 B 122 B 123	B 220 B 222 B 223
4 ... 20	B 121	B 221	2 ... 10	B 121 B 122 B 123	B 221 B 222 B 223
± 20	—	—	±10	B 122 B 123	B 222 B 223

3. Specific user output ranges

Units that have been configured for a specific user output range cannot be subsequently reconfigured.

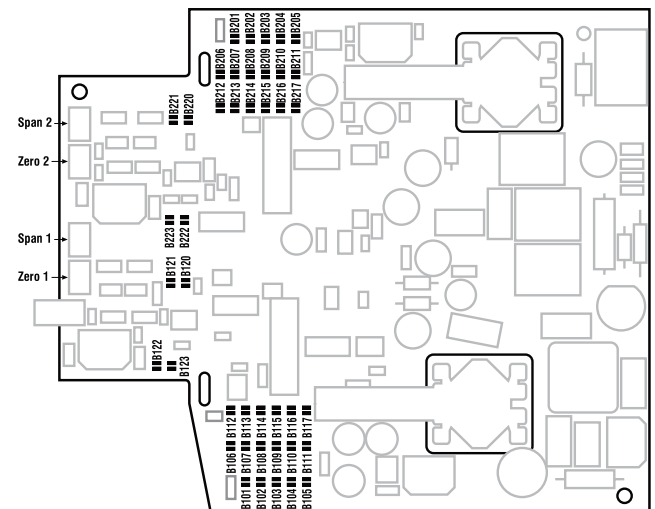
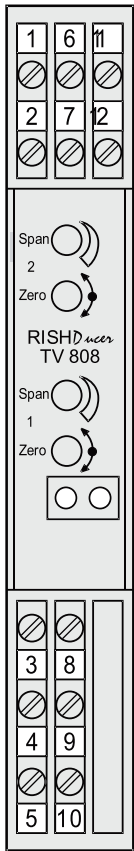

Fig. 3. Position of the soldered jumpers B ... and the potentiometers "Span" and "Zero".

Electrical connections

Front



Without transparent cover

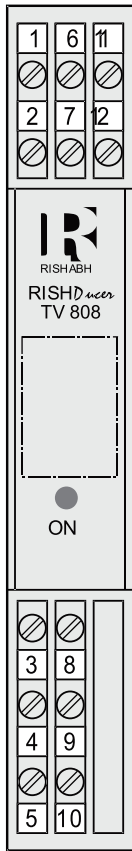

With transparent cover

● ON
Green LED for device standing by

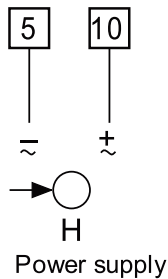
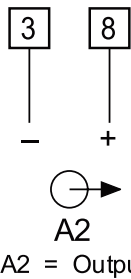
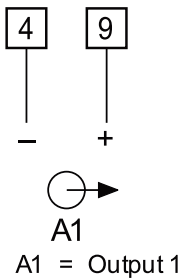
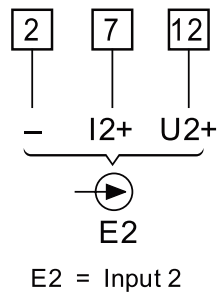
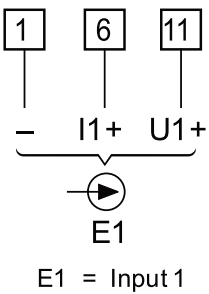

Dimensional Drawings

All Dimensions are in mm

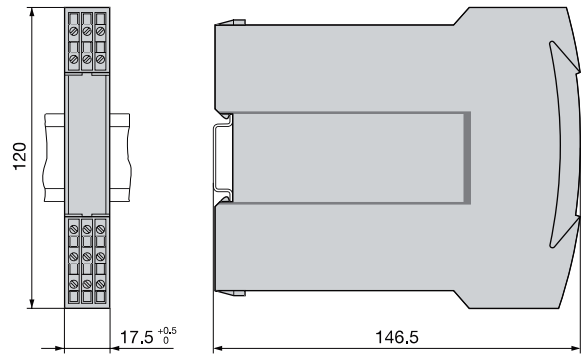

Fig. 4. *RISHD user* TV 808 in housing S 17 clipped onto a top - hat rail (35 x 15 mm or 35 x 7.5 mm, acc to EN 50 022).

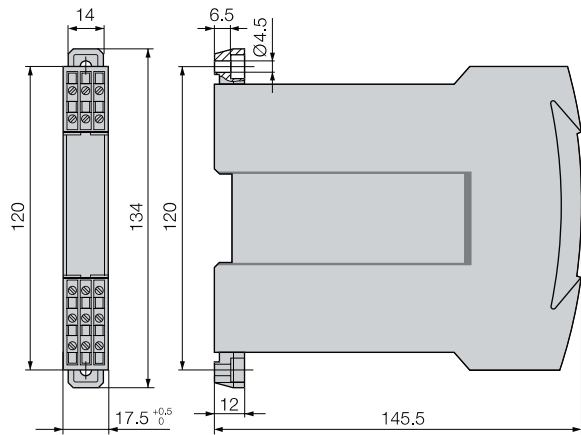

Fig. 5. *RISHD user* TV 808 in housing S 17, screw hole mounting brackets pulled out

Standard version

Inputs and outputs set to 0 ... 20 mA. Any of the standard ranges given in the Section "Technical data, measuring inputs" are simply selected by positioning soldered jumpers. The fine adjustment is accomplished using the potentiometers "Zero" and "Span".

Table 1: Standard version with 2 inputs and 2 outputs

Standard range		Power supply	Order No.
Inputs 1 and 2	Outputs 1 and 2		
0...20mA	0...20mA	24... 60 V DC/AC	128 802
		85...230 V DC/AC	128 810

Table 2: Standard version with 1 input and 2 outputs

Standard range		Power supply	Order No.
Input 1	Outputs 1 and 2		
0...20mA	0...20mA	24... 60 V DC/AC	128 828
		85...230 V DC/AC	128 836

Table 3: Standard version with 1 input and 1 output

Standard range		Power supply	Order No.
Input 1	Output 1		
0...20mA	0...20mA	24... 60 V DC/AC	124 404
		85...230 V DC/AC	124 412

Please complete the Order Code 808 - 12... according to "Table - 4 : Ordering information" for versions with user - specific input and / or output ranges.

Standard accessories

1. Operating instructions
2. Pull out clamp S 17 (For operating the housing)
3. Front Labels

Table No- 4 : Ordering Information

(see also Table 1, 2 and 3: "Standard versions")

DESCRIPTION	MARKING
1. Mechanical Design Housing S17 for rail and wall mounting	808 - 1
2. Number of channels 1) 1 channel 2) 2 channels	1 2
3. Version / power supply 1) Standard, 24 ... 60 V DC/AC 2) Standard, 85 ... 230 V DC/AC	1 2
4. Function 1) 1 inputs, 1 electrically insulated output 2) 2 inputs, 2 electrically insulated outputs 3) 1 inputs, 2 electrically insulated outputs	1 2 3
5. Input signal, input 1 9) Input [V] <input type="text"/> Z) Input [mA] <input type="text"/> Line 9: [V] 0 ... 0.06 to 0 ... 40 also live - zero, start value > 0 to ≤ 50% final value or span 0.06 to 40 V between - 40 and 40 V (also bipolar asymmetrical) Non-Standard Ranges: 0...1000VDC Line Z: [mA] 0 ... 0.1 to 0 ... 40 also live - zero, start value > 0 to ≤ 50% final value or span 0.1 to 40 mA between - 40 and 40 mA (also bipolar asymmetrical)	9 Z
6. Output signal, output 1 9) Output [V] <input type="text"/> Z) Output [mA] <input type="text"/> Line 9: [V] 0 ... 1 to 0 ... 10 0.2 ... 1 to 2 ... 10 -1 ... 0 ... +1 to -10 ... 0 ... +10 Line Z: [mA] 0 ... 1 to 0 ... 20 0.2 ... 1 to 4 ... 20 -1 ... 0 ... +1 to -20 ... 0 ... +20 or span 0.1 to 40 mA between - 40 and 40 mA (also bipolar asymmetrical)	9 Z
7. Input signal, input 2 0) Without input 2 9) Input [V] <input type="text"/> Z) Input [mA] <input type="text"/> Ranges possibles see input 1	0 9 Z
8. Output signal, output 2 9) Output [V] <input type="text"/> Z) Output [mA] <input type="text"/> Ranges possibles see output 1	9 Z

Possible special versions, e.g. increased climatic rating on inquiry.



RISHABH

All specifications are subject to change without notice



Measure



Control



Record



Analyze

RISHABH INSTRUMENTS LIMITED.

Domestic (India): +91 253 2202028/99 | marketing@rishabh.co.in

International: +91 253 2202004/06/08/99 | global@rishabh.co.in

www.rishabh.co.in